



PROTEU®

SOLUTIONS



Tabela de preços Climatização

01-26

www.proteu.pt

Ar condicionado	06
Bombas de Calor Monobloco	14
Termoacumulador	19
Bombas de Calor AQS	21
Bombas de Calor Piscina	24
Ventiloconvectores	28
Ventilação	30

Conheça as soluções Proteu®

Ar condicionado

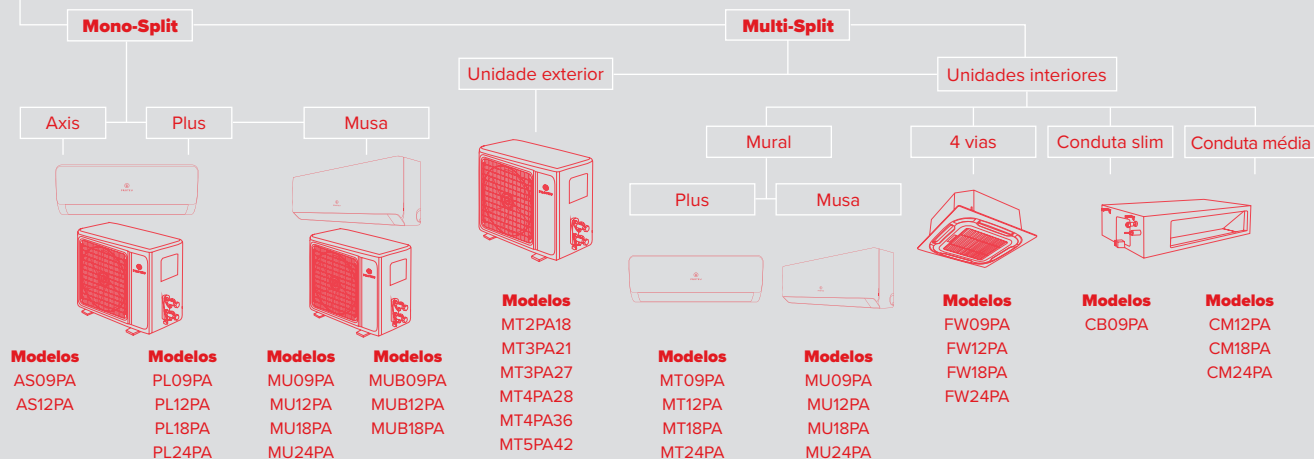

Bombas de Calor AQS

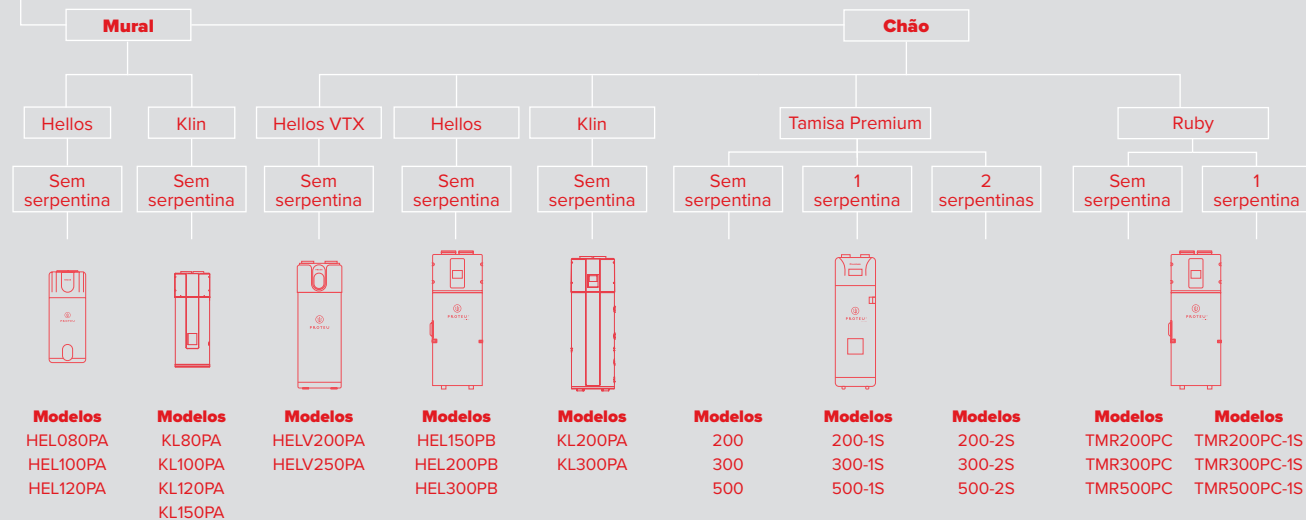

Ventilação

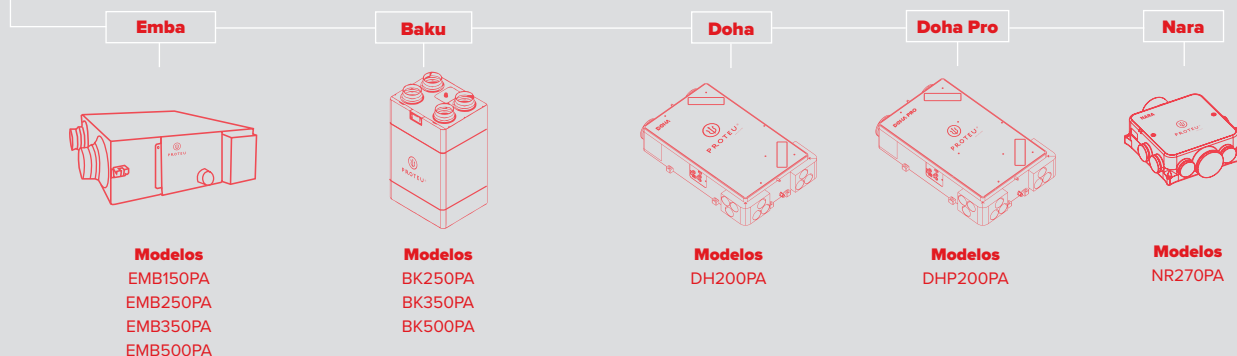

Bombas de Calor

Monofásicas

Queen

Queen Compact



Modelos

AR061PA
AR101PA
AR121PA
AR141PA
AR161PA

Modelos

PBL041PA
PBL061PA
PBL101PA
PBL121PA
PBL151PA

Trifásicas

Queen

Queen Compact

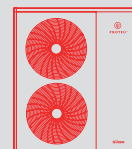
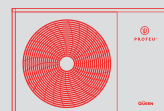

Modelos

AR123PA
AR143PA
AR163PA

Modelos

PBL123PA
PBL153PA

Modelos

PBL203PA

Termoacumulador

Báltico

Ligações laterais

Ligações superiores



Modelos

BL010200
BL010300
BL010500

Modelos

BS010200
BS010300
BS010500

Bombas de Calor de piscina

Monofásicas

Aloha

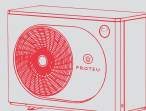

Modelos

AL070PA
AL100PA
AL125PA
AL150PA
AL180PA
AL240PA

Trifásicas

Aloha

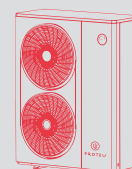

Modelos

AL28TPA

Ventiloconvectores

Bern

Ligações à esquerda

Ligações à direita

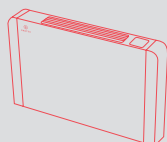

Modelos

BER020015
BER020030
BER020035
BER020045

Modelos

BER010015
BER010030
BER010035
BER010045



Ar

Con-



dicio-

nado

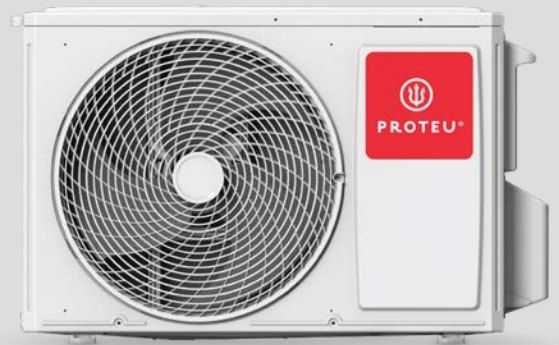



Proteu®

MUSCA

A ARTE DO CONFORTO

8

Wifi integrado



Conforto sempre à mão



Escolha através do seu smartphone ou tablet a direção do fluxo de ar



Ligue ou desligue remotamente o seu equipamento, entre em casa com a temperatura perfeita



Garanta o seu conforto sem preocupações. Programe os dias e horas desejadas e o equipamento entra em ação.



Disponha de todas as informações úteis do seu equipamento no ecrã do seu dispositivo móvel.

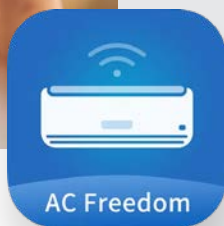

Descarregue a APP

Que lhe permite controlar o seu ar condicionado



Mono-Split

9

Proteu® Axis

Unidade interior
+ Unidade exterior



Modelo	PVP	Arref./Aquec. [kW]	SEER/SCOP	Class. energética	Unidade	Dimensões LxAxP [mm]	P. sonora [dB (A)]
AS09PA	478 €	2,6/2,6	6,1/4,0	A++/A+	Interior	690x283x199	21
					Exterior	649x450x232	49,5
AS12PA	498 €	3,4/3,5	6,2/4,0	A++/A+	Interior	750x285x200	23
					Exterior	649x450x232	53,5

Proteu® Plus

Unidade interior
+ Unidade exterior



WiFi
Incluído



Modelo	PVP	Arref./Aquec. [kW]	SEER/SCOP	Class. energética	Unidade	Dimensões LxAxP [mm]	P. sonora [dB (A)]
PL09PA	518 €	2,6/2,6	6,1/4,0	A++/A+	Interior	690x283x199	21
					Exterior	649x450x232	49,5
PL12PA	556 €	3,4/3,5	6,2/4,0	A++/A+	Interior	750x285x200	23
					Exterior	649x450x232	53,5
PL18PA	950 €	5,1/5,2	6,7/4,0	A++/A+	Interior	900x310x225	24
					Exterior	708x530x258	52,8
PL24PA	1160 €	7,2/7,2	6,1/4,0	A++/A+	Interior	1082x330x233	27
					Exterior	823x655x302	53,6

Dimensões da tubagem

Modelo	C Comp. máx. [m]	D desnível máx. [m]	Carga ad. [g/m] *	Ø tub. líq./gás [pol.]
AS09PA	20	10	20	1/4" - 3/8"
AS12PA	20	10	20	1/4" - 3/8"
PL09PA	20	10	20	1/4" - 3/8"
PL12PA	20	10	20	1/4" - 3/8"
PL18PA	20	10	20	1/4" - 1/2"
PL24PA	25	15	25	1/4" - 5/8"

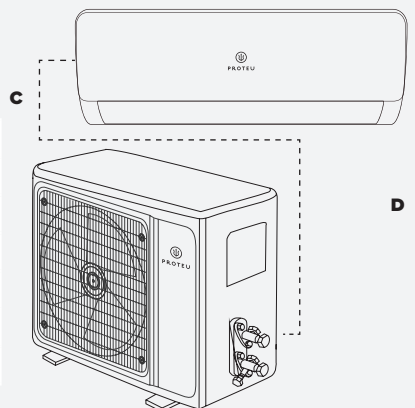

* Para comprimento de tubagem inferior a 5m não é necessário adicionar gás R32 ao circuito. Para comprimentos de tubagem superior a 5m é necessário adicionar gás R32 ao circuito. Neste caso deverá considerar a seguinte fórmula de cálculo:
carga adicional (g) = n° g/m x (comprimento total da tubagem de líquido - 5 x n° de unidades interiores)

10 Mono-Split

Proteu® *nusa*

Unidade interior
+ Unidade exterior



**Aquecimento
Arrefecimento**
rápido



**Esterilização
de ar UVC**



**Design
sofisticado**



WIFI
Incluído



NOVO

Modelo	PVP	Arref./Aquec. [kW]	P. sonora [dB (A)]	SEER/SCOP	C. Energética	Unidade	Dimensões LxAxP [mm]
MU09PA	630 €	2,7 / 3,3	21	8,7 / 4,7	A+++/A+++	Interior	768x299x201
			49,5			Exterior	708x530x258
MU12PA	665 €	3,5 / 4,2	23	8,5 / 4,6	A+++/A+++	Interior	827x299x201
			53,5			Exterior	708x530x258
MU18PA	1175 €	5,4 / 5,8	24	8,7 / 4,6	A+++/A+++	Interior	1140x332x230
			52,8			Exterior	785x548x281
MU24PA	1400 €	7,2 / 7,3	27	8,7 / 7,6	A+++/A+++	Interior	1140x332x230
			53,6			Exterior	890x695x319



NOVO



Modelo	PVP	Arref./Aquec. [kW]	P. sonora [dB (A)]	SEER/SCOP	C. Energética	Unidade	Dimensões LxAxP [mm]
MUB09PA	695 €	2,7 / 3,3	21	8,7 / 4,7	A+++/A+++	Interior	768x299x201
			49,5			Exterior	708x530x258
MUB12PA	730 €	3,5 / 4,2	23	8,5 / 4,6	A+++/A+++	Interior	827x299x201
			53,5			Exterior	708x530x258
MUB18PA	1300 €	5,4 / 5,8	24	8,7 / 4,6	A+++/A+++	Interior	1140x332x230
			52,8			Exterior	785x548x281

**Dimensões
da tubagem**

Modelo	C Comp. máx. [m]	D desnível máx. [m]	Carga ad. [g/m] *	Ø tub. líq./gás [pol.]
MU09PA MUB09PA	20	10	16	1/4" - 3/8"
MU12PA MUB12PA	20	10	16	1/4" - 3/8"
MU18PA MUB18PA	20	10	24	1/4" - 1/2"
MU24PA MUB24PA	25	15	24	1/4" - 5/8"

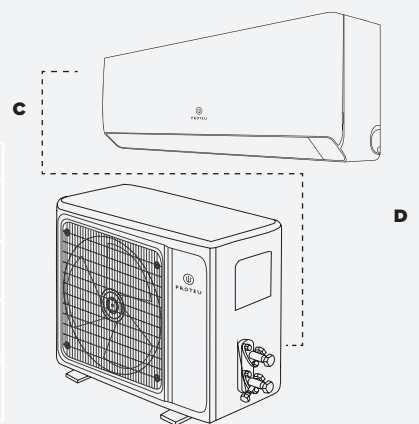

* Para comprimento de tubagem inferior a 7m não é necessário adicionar gás R32 ao circuito. Para comprimentos de tubagem superior a 7m é necessário adicionar gás R32 ao circuito. Neste caso deverá considerar a seguinte fórmula de cálculo: carga adicional (g) = n° g/m x (comprimento total da tubagem de líquido - 7 x n° de unidades interiores)

NOVO



NOVA

musica

BLACK



Aquecimento
Arrefecimento
rápido



Esterilização
de ar UVC



Design
sofisticado



WIFI
Incluído

12 Multi-Split

Unidade exterior



Modelo	PVP	Arref./Aqc. [kW]	P. sonora [dB(A)]	SEER/SCOP	C. energ.	Máx. Ui	Temp. Arref./Aquec. [°C]	Dim. LxAxP [mm]	Peso [kg]
MT2PA18	934 €	5,3 / 5,6	54	6,8 / 4,6	A++/A+	2	-10~-52 / -15~-24	785x555x300	30,5
MT3PA21	1248 €	6,2 / 6,6	56	6,1 / 4,1	A++/A+	3	-10~-52 / -15~-24	900x700x350	41,5
MT3PA27	1414 €	7,9 / 8,2	57	6,8 / 4,6	A++/A+	3	-10~-52 / -15~-24	900x700x350	41,5
MT4PA28	2215 €	8,2 / 8,7	59	7,1 / 4,4	A++/A+	4	-10~-52 / -15~-24	985x803x395	65,5
MT4PA36	2640 €	10,5 / 11	60	6,5 / 4,1	A++/A+	4	-10~-52 / -15~-24	985x803x395	63,5
MT5PA42	2954 €	12,0 / 13,0	61	6,2 / 4,0	A++/A+	5	-10~-52 / -15~-24	985x803x395	75

NOVO

Dimensões da tubagem

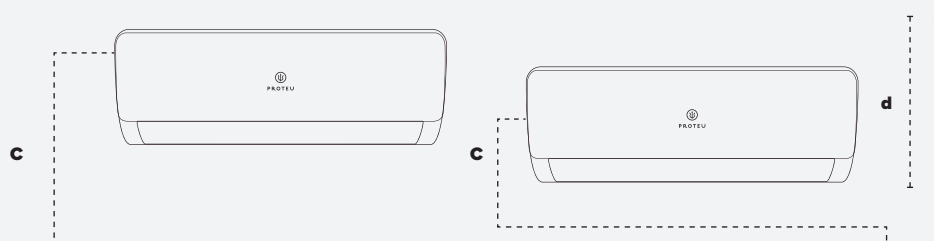

Modelo	Comp. total [m]	C Comp. máximo [m]	Desnível máx [m]		Carga adicional. [g/m]	ø tubagem líq./gás [pol.]
			D (Int.-Ext.)	d (Int.-Int.)		
MT2PA18	40	25	15	10	15	1/4" - 3/8"
MT3PA21	60	30	15	10	25	1/4" - 3/8"
MT3PA27	60	30	15	10	15	1/4" - 3/8"
MT4PA28	80	35	15	10	15	1/4" - 3/8"
MT4PA36	80	35	15	10	15	1/4" - 3/8"
MT5PA42	80	35	15	10	25	1/4" - 3/8"

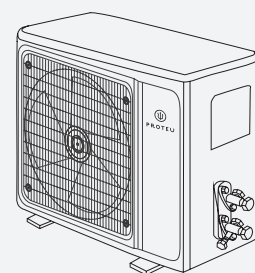

* Para comprimento de tubagem inferior a 7,5m não é necessário adicionar gás R32 ao circuito. Para comprimentos de tubagem superior a 7,5m é necessário adicionar gás R32 ao circuito. Neste caso deverá considerar a seguinte fórmula de cálculo:
 carga adicional(g) = n° g/m x (comprimento total da tubagem de líquido - 7,5 x n° de unidades interiores)



WIFI Incluído
(em todos os modelos desta página)



Unidade interior mural Plus

Modelo	PVP	Arref./Aquec. [kW]	P. sonora [dB(A)]	ø tub. liq./gás [pol]	Dimensões LxAxP [mm]
MT09PA	178 €	2,64 / 2,93	32	1/4" - 3/8"	750x285x200
MT12PA	190 €	3,52 / 3,81	33	1/4" - 3/8"	750x285x200
MT18PA	248 €	5,27 / 5,38	35	1/4" - 1/2"	900x310x225
MT24PA	304 €	6,90 / 7,05	37	1/4" - 5/8"	1082x330x233

Unidade interior mural *nusa*

NOVO



Modelo	PVP	Arref./Aquec. [kW]	P. sonora [dB(A)]	ø tub. liq./gás [pol]	Dimensões LxAxP [mm]
AP09PA	190 €	2,64 / 2,93	35	1/4" - 3/8"	768x299x201
AP12PA	204 €	3,52 / 3,81	35	1/4" - 3/8"	768x299x201
AP18PA	282 €	5,27 / 5,38	36	1/4" - 1/2"	1004x320x223
AP24PA	318 €	6,90 / 7,05	40	1/4" - 5/8"	1140x332x230

Unidade interior 4 vias



Modelo	PVP	Arref./Aquec. [kW]	P. sonora [dB(A)]	ø tub. liq./gás [pol]	Dimensões LxAxP [mm]	
					Corpo	Painel
FW09PA	484 €	2,80 / 3,0	32	1/4" - 1/2"	570x570x260	650x650x55
FW12PA	518 €	3,52 / 3,81	32	1/4" - 1/2"	570x570x260	650x650x55
FW18PA	530 €	5,28 / 5,60	38	1/4" - 1/2"	570x570x260	650x650x55
FW24PA	850 €	7,0 / 8,0	42	1/4" - 5/8"	840x840x246	950x950x55

Bomba de condensados incluída

Conduatas



Modelo	PVP	Pressão estática	Arref./Aquec. [kW]	P. sonora [dB(A)]	ø tub. liq./gás [pol]	Dimensões LxAxP [mm]
CB09PA	532 €	Baixa	2,60 / 2,90	30	1/4" - 3/8"	700x200x470
CM12PA	560 €	Média	3,52 / 3,81	32	1/4" - 1/2"	700x245x700
CM18PA	615 €	Média	5,28 / 5,60	34	1/4" - 1/2"	700x245x700
CM24PA	769 €	Média	7,03 / 7,91	36	3/8" - 5/8"	1000x245x700

Bomba de condensados incluída

Bombas
de



Calor

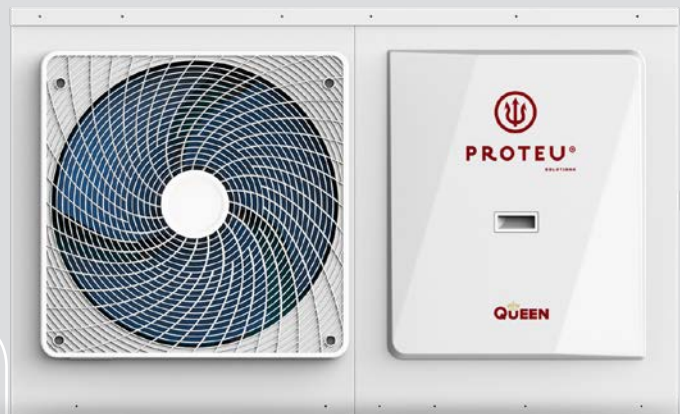

Monobloco

Bomba de calor

Conforto e Eficiência

A Bomba de Calor Monobloco Proteu® Queen foi desenvolvida para atender às crescentes demandas por conforto, economia de energia e sustentabilidade, esta unidade compacta está pronta para elevar sua experiência de climatização a um novo patamar.

Design Compacto, Desempenho Poderoso

O seu tamanho reduzido não compromete o desempenho. Pelo contrário, oferece um desempenho poderoso e confiável, mantendo sua casa aquecida no inverno e fresca no verão.



Ampla gama de funcionamento



Aquecimento, arrefecimento e AQS

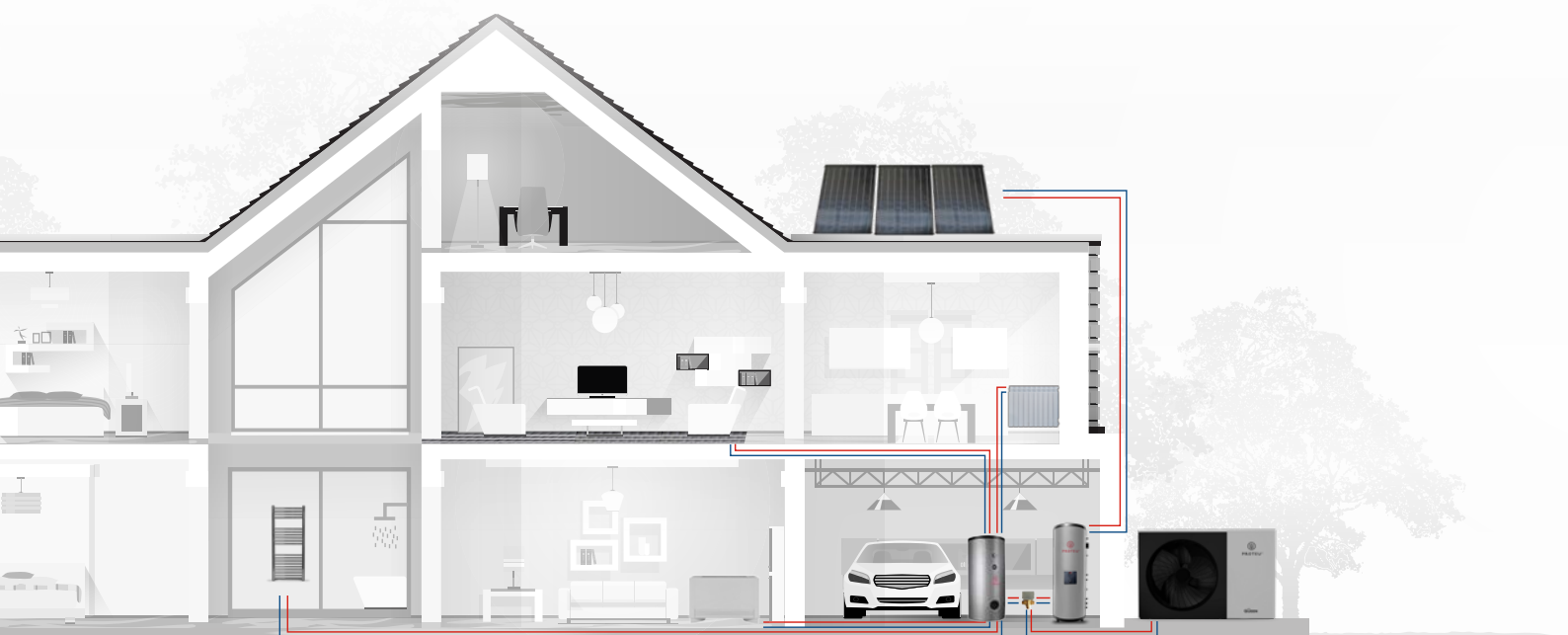

Proteu® QUEEN



Arranque obrigatório
Incluído



WIFI
Incluído

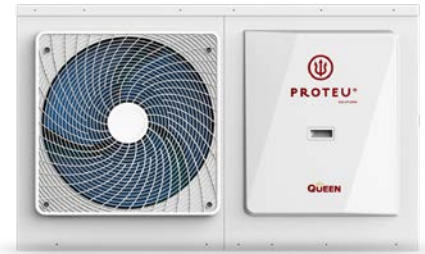

Monofásica

Modelo	PVP	Arref./Aquec. [kW]	COP/EER	Class. Energética	P. sonora [dB(A)]	T. saída água aqc/arref. [°C]
AR061PA	3630 €	6,4 / 6,6	4,95 / 4,90	A+++	45	12 a 65 / 5 a 25
AR101PA	4565 €	10 / 10	5,00 / 4,80		47	
AR121PA	4997 €	12,2 / 12,0	4,96 / 4,00		52	
AR141PA	5290 €	14,5 / 13,6	4,71 / 3,60		55	
AR161PA	5480 €	16,1 / 15,0	4,51 / 3,40			

Trifásica

Modelo	PVP	Arref./Aquec. [kW]	COP/EER	Class. Energética	P. sonora [dB(A)]	T. saída água aqc/arref. [°C]
AR123PA	5565 €	12,2 / 12,0	4,96 / 4,00	A+++	52	12 a 65 / 5 a 25
AR143PA	5730 €	14,5 / 13,6	4,71 / 3,60			
AR163PA	5910 €	16,1 / 15,0	4,51 / 3,40		55	

Esquema de dimensões

Modelo	A mm	B mm	C mm
AR061PA	765	1265	323
AR101PA	933	1385	520
AR121PA			
AR141PA			
AR161PA			
AR123PA			
AR143PA			
AR163PA			

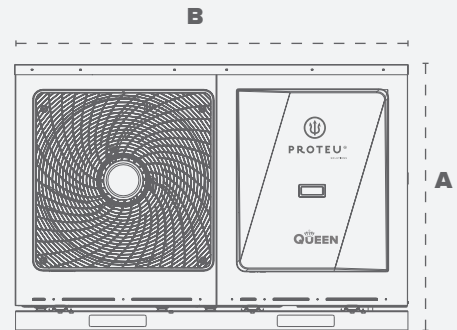
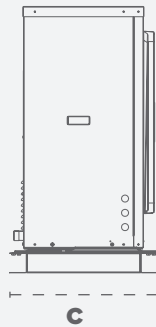

Classificação Energética



Tecnologia Inverter



Modo Ecológico



Sonda AQS incluída

Descarregue a APP

Que lhe permite controlar o seu ar condicionado





PROTEU®
SOLUTIONS

LANÇAMENTO

QUEEN
COMPACT

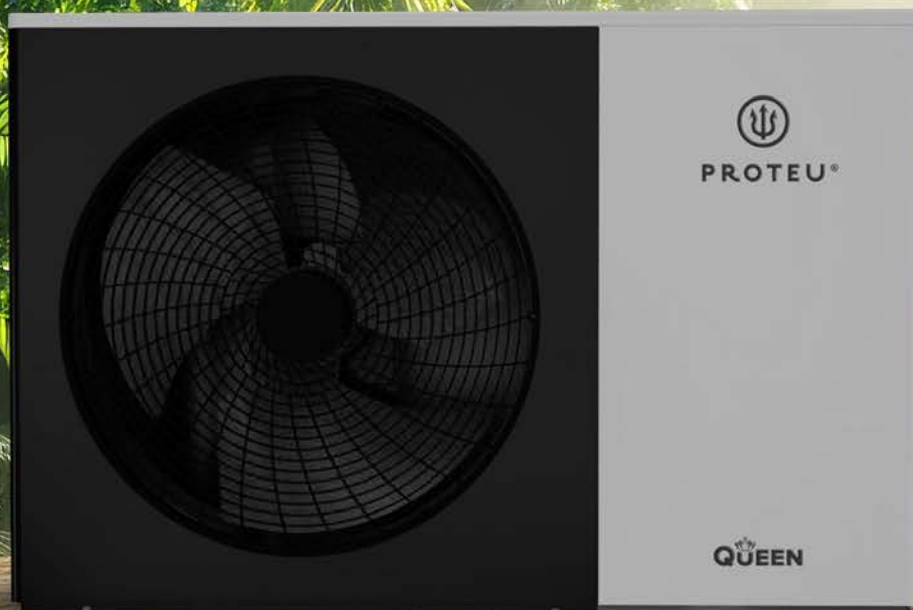

**Compacta no tamanho.
Gigante no desempenho.**

Conheça a Queen Compact.
A nova bomba de calor
monobloco da Proteu

Proteu®
a pensar no
seu conforto

www.proteu.pt
geral@proteu.pt



Proteu® QUEEN COMPACT



Arranque obrigatório
Incluído



WIFI
Incluído

NOVO



Monofásica

Modelo	PVP	Arref./Aquec. [kW]	COP/EER	Class. Energética	P. sonora [dB(A)]	T. saída água aqc/arref. [°C]
PBL041PA	3310 €	4,0 / 3,19	4,70 / 3,01	A+++	43	10 a 60 / 8 a 28
PBL061PA	3630 €	6,0 / 4,84	4,89 / 3,10	A+++	43	10 a 60 / 8 a 28
PBL101PA	4565 €	10,0 / 8,07	4,96 / 3,14	A+++	43	10 a 60 / 8 a 28
PBL121PA	4997 €	12,0 / 9,70	5,08 / 3,18	A+++	45	10 a 60 / 8 a 28
PBL151PA	5290 €	15,0 / 11,92	5,02 / 3,16	A+++	45	10 a 60 / 8 a 28

Trifásica

Modelo	PVP	Arref./Aquec. [kW]	COP/EER	Class. Energética	P. sonora [dB(A)]	T. saída água aqc/arref. [°C]
PBL123PA	5565 €	12,0 / 9,70	5,08 / 3,18	A+++	45	10 a 60 / 8 a 28
PBL153PA	5730 €	15,0 / 11,92	5,02 / 3,16	A+++	45	10 a 60 / 8 a 28



Trifásica

Modelo	PVP	Arref./Aquec. [kW]	COP/EER	Class. Energética	P. sonora [dB(A)]	T. saída água aqc/arref. [°C]
PBL203PA	7560 €	20,0 / 16,8	4,76 / 3,02	A+++	47	10 a 60 / 8 a 28

Esquema de dimensões

Modelo	A mm	B mm	C mm
PBL041PA	870	591	453
PBL061PA	920	640	475
PBL101PA	1090	690	497
PBL121PA	1090	840	497
PBL151PA	1270	890	535
PBL123PA	1090	840	497
PBL153PA	1270	890	535
PBL203PA	1120	1220	480

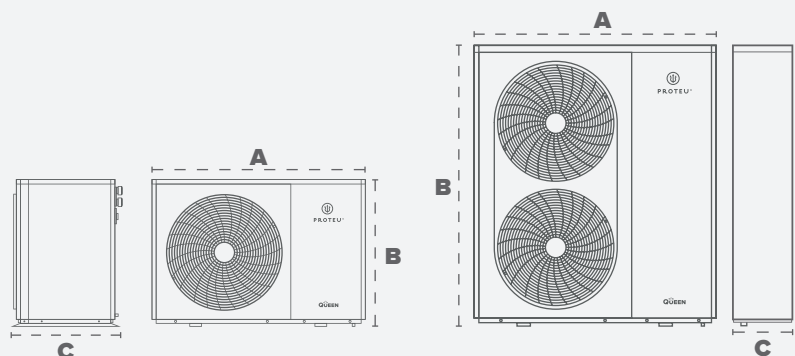

Classificação Energética



Tecnologia Inverter



Modo Ecológico



Sonda AQS incluída

Termo- acumu- lador



20 Termoacumulador para bomba de calor

Proteu® Báltico

O Termoacumulador Báltico é um produto de alta performance, ideal para sistemas de aquecimento de água, destacando-se pela sua serpentina de grande área de permuta, que o torna perfeito para trabalhar com bomba de calor.

O seu depósito em aço inox garante durabilidade e resistência à corrosão, enquanto o isolamento térmico de 50 mm de espessura reduz as perdas de energia, aumentando a eficiência energética. Com essas características, o Termoacumulador Báltico proporciona aquecimento eficiente, económico e sustentável, sendo uma excelente escolha para quem procura qualidade e performance.



Modelo	PVP	Capacidade [l]	Isolamento	Espessura isolamento	Área permutador mm]	Resistência [W]	Ligações permutador [pol]	Ligações sanitárias [pol]	Peso [Kg]
BL010200 BS010200	1184 €	200	Regranulado de cortiça desidratada	50	1,91	1500	3/4" M	3/4" M	51,5
BL010300 BS010300	1386 €	300		50	2,65	1500	1" M	3/4" M	55,5
BL010500 BS010500	2276 €	500		63	4	2500	1" M	1" M	109



Esquema de dimensões

Modelo	A mm	B mm
BL010200 BS010200	1320	590
BL010300 BS010300	1610	
BL010500 BS010500	1840	755

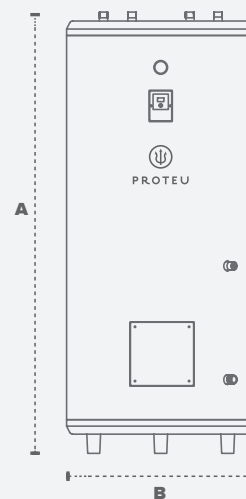

Alta performance
Área de permuta



AÇO INOX
Material depósito e permutador



Ligações superiores
disponíveis



Ligações laterais
Disponíveis



Termómetro
Incluído

Bombas de Calor



AQS

22 Bombas de calor AQS

RUBY



Adicione o seu equipamento à aplicação **Smart life** e obtenha em tempo real todas as informações acerca do seu funcionamento.



Classificação Energética



WIFI Incluído



Material Cuba



Ânodo eletrónico



Capacete Bipartido 200 / 300L

NOVO MODELO



Modelo	PVP	Capacidade [l]	COP EN16147	Fluido frigorigéneo	P. Sonora [dB(A)]	Comp. máx. condutas [m]	Dimensões ØxA [mm]
TMR200PC	2450 €	200	4,12	R134a	37,9	8	560x1750
TMR200PC-1S	2590 €						560x1750
TMR300PC	2560 €	300	4,15		39,1		640x1845
TMR300PC-1S	2690 €						640x1845
TMR500PC	4080 €	500	4,01		40,1		700x2250
TMR500PC-1S	4280 €						700x2250

Capacete Bipartido

- A** Capacete
- B** Evaporador
- C** Compressor
- D** Ventoinha motor
- E** Caixa elétrica
- F** Depósito de água



Tamisa Premium



Classificação Energética



Ânodo eletrónico

Modelo	PVP	Capc. [l]	COP EN16147	Fluido frigor.	P. Sonora [dB(A)]	Comp. máx. condutas [m]	Dimensões ØxA [mm]	
200	2450 €	200	3,57	R134a	49	8	590x1685	
200-1S	2590 €						590x1685	
200-2S	2842 €						590x1685	
300	2500 €	300	3,61		49		8	590x2040
300-1S	2670 €							590x2040
300-2S	2890 €				590x2040			
500	4080 €	500	3,45	42	8	755x2300		
500-1S	4290 €					755x2300		
500-2S	4470 €					755x2300		



NOVO MODELO



PROTEU®
SOLUTIONS

RUBY

DESIGN RENOVADO,
CONFORTO REFORÇADO

Bomba de calor AQS Inox

NOVO MODELO

HELLOS

Material

WIFI
Incluído

Classificação
Energética

Capacete
Bipartido
150 / 200 / 300

Adicione o seu equipamento à aplicação **Smart life** e obtenha em tempo real todas as informações acerca do seu funcionamento.



Mural

Modelo	PVP	Capacidade [l]	COP EN16147	Fluido frigor.	P. Sonora [dB(A)]	Comp. máx. condutas [m]	Dimensões ØxA [mm]
HEL100IPA	1470 €	100	4,04	R134a	37,9	6	510x1180

Chão

Modelo	PVP	Capacidade [l]	COP EN16147	Fluido frigor.	P. Sonora [dB(A)]	Comp. máx. condutas [m]	Dimensões ØxA [mm]
HEL150IPB	1930 €	150	4,04	R134a	46	8	560x1500
HEL200IPB	2090 €	200	4,12				560x1750
HEL300IPB	2315 €	300	4,15				640x1845

Bomba de calor AQS Vitrificada

HELLOS

WIFI
Incluído

Classificação
Energética

Ânodo
eletrónico

Adicione o seu equipamento à aplicação **Tuya** e obtenha em tempo real todas as informações acerca do seu funcionamento.



Mural

Modelo	PVP	Capacidade [l]	COP EN16147	Fluido frigor.	P. Sonora [dB(A)]	Comp. máx. condutas [m]	Dimensões ØxA [mm]
HEL080PA	1336 €	80	4,39	R134a	44	8	548x1250
HEL100PA	1390 €	100	4,01		45		548x1390
HEL120PA	1430 €	120	3,88		46		548x1550

Chão

Modelo	PVP	Capacidade [l]	COP EN16147	Fluido frigor.	P. Sonora [dB(A)]	Comp. máx. condutas [m]	Dimensões ØxA [mm]
HELV200PA	1880 €	200	3,97	R134a	43	6	662x1530
HELV250PA	1960 €	250	3,92				662x1770

Bomba de calor AQS R290

Proteu® KLIN



Capacete Bipartido



WIFI Incluído



Classificação Energética



Gás R290

NOVO



Adicione o seu equipamento à aplicação **Smart life** e obtenha em tempo real todas as informações acerca do seu funcionamento.

Mural

Modelo	PVP	Capacidade [l]	COP EN16147	Fluido frigor.	P. Sonora [dB(A)]	Comp. máx. condutas [m]	Dimensões ØxAlt [mm]
KL80PA	1245 €	80	4,08	R290	40	6	510x1075
KL100PA	1260 €	100	4,28				510x1210
KL120PA	1425 €	120	4,30				510x1325
KL150PA	1575 €	150	4,40				510x1600

Chão

Modelo	PVP	Capacidade [l]	COP EN16147	Fluido frigor.	P. Sonora [dB(A)]	Comp. máx. condutas [m]	Dimensões ØxAlt [mm]
KL200PA	1740 €	200	4,50	R290	42	8	560x1750
KL300PA	1970 €	300	4,55				640x1970

Capacete Bipartido

- A** Capacete
- B** Evaporador
- C** Ventoinha motor
- D** Caixa elétrica
- E** Depósito de água



Bomba de Calor



Pis- cina



Bomba de calor de piscina

Proteu® Aloha

Monofásica



WiFi
Incluído



Modelo	PVP	Pot. Term. Aqc. Ar (26°) /Água (26°) [kW]	Alim. elétrica	Ruído 10m [dB(A)]	Int. Temp. Aqc. [°C]
AL070PA	1390 €	1,75 - 7,19	220-240V /50Hz/1ph	29	15 a 40
AL100PA	1895 €	2,35 - 10,05		29	
AL125PA	2195 €	2,85 - 12,82		30	
AL150PA	2496 €	3,56 - 15,39		30	
AL180PA	2780 €	4,30 - 18,46		31	
AL240PA	3898 €	6,31 - 24,34		33	

Trifásica

Modelo	PVP	Pot. Term. Aqc. Ar (26°) /Água (26°) [kW]	Alim. elétrica	Ruído 10m [dB(A)]	Int. Temp. Aqc. [°C]
AL28TPA	5100 €	6,61 - 28,7	380-415V /50Hz/3ph	37	15 a 40

Esquema de dimensões

Modelo	A mm	B mm	C mm
AL070PA	590	875	345
AL100PA			
AL125PA	712	1120	480
AL150PA			
AL180PA			
AL240PA	1220	1120	480
AL28TPA			

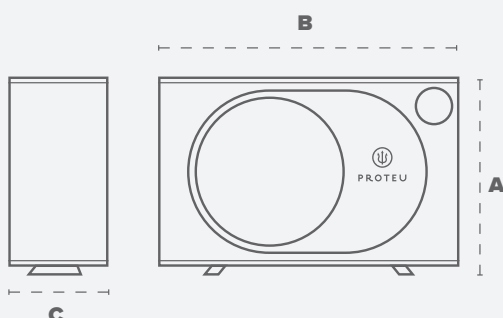

Adicione o seu equipamento à aplicação **Smart life** e obtenha em tempo real todas as informações acerca do seu funcionamento.

Ventilador-convectores



Proteu® Bern



WIFI
Includido



Modelo	PVP	Cap. Arref./Aquec. [kW]	Caudal ar [m3/h]	P. sonora dB [(A)]	Lig. água [pol.]	Lig. Hidraulicas
BER010015	680 €	1,1 / 1,45	160	24	3/4"	Direita
BER020015						Esquerda
BER010030	740 €	2,1 / 2,8	320	27		Direita
BER020030						Esquerda
BER010035	800 €	2,65 / 3,45	460	28		Direita
BER020035						Esquerda
BER010045	860 €	3,7 / 4,4	580	28		Direita
BER020045						Esquerda

Esquema de dimensões

Modelo	A mm	B mm	C mm
BERN15	586	730	125
BERN30		930	
BERN35		1130	
BERN45		1330	

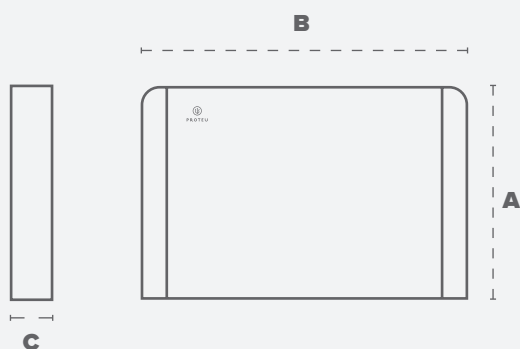

Design
slim



Display
intuitivo



Aquecimento
e arrefecimento



Funcionamento
silencioso



**Válvula de 3 Vias
para ventiloconvetor
Proteu® Bern**

160 €

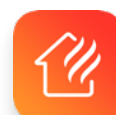

Adicione o seu equipamento à aplicação **WarmLink** e obtenha em tempo real todas as informações acerca do seu funcionamento.

Ven-



tila-
ção

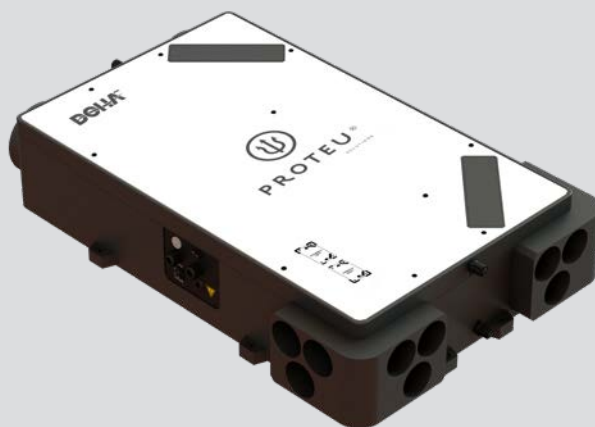

Proteu® Emba Caixa de Recuperação de Energia

As caixas de recuperação de energia Proteu® Emba são a solução ideal para edifícios energeticamente mais eficientes.

Dotados de sistemas de controlo inteligente, como controlo de CO2 e humidade, controlo externo e controlo BMS, este equipamento propociona o máximo conforto e elevada eficiência.



Modelo	PVP	Caudal ar [m3/h]	Pressão estática [Pa]	Efic. térmica [%]	Nível ruído [dB(A)]	Dim. condutas [mm]
EMB150PA	1100 €	150	70	75 - 80	25	150
EMB250PA	1180 €	250	90	73 - 81	27	150
EMB350PA	1390 €	350	140	74 - 82	33	150
EMB500PA	1600 €	500	110	76 - 84	38	200

Esquema de dimensões

Modelo	A mm	B mm	C mm
EMB150PA	264	736	580
EMB250PA	270	814	599
EMB350PA	270	814	804
EMB500PA	270	894	904

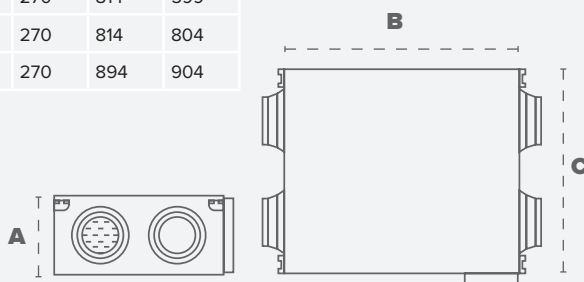

WiFi
Incluído



ERP
2018
Produto
Certificado



Filtros
G4 e F9



Sensor
Humidade e CO²



Adicione o seu equipamento à aplicação **Smart life** e obtenha em tempo real todas as informações acerca do seu funcionamento.

Proteu® Baku Recuperador de duplo fluxo

Renove o ar da sua habitação sem comprometer o conforto interior e a eficiência do sistema de climatização.

O recuperador de duplo fluxo Baku da Proteu®, oferece a capacidade de remover a humidade do ar e fornecer ar novo proveniente do exterior durante todo o ano, sem oscilações térmicas.



Modelo	PVP	Caudal ar [m3/h]	Pressão estática [Pa]	Efic. térmica [%]	Nível ruído [dB(A)]	Dim. condutas [mm]
BK250PA	1920 €	250	130	95%	35	160
BK350PA	2300 €	350	150		37	160
BK500PA	2600 €	500	160		39	200



Esquema de dimensões

Modelo	A mm	B mm	C mm
BK250PA	975	595	480
BK350PA	975	595	480
BK500PA	1085	655	624,5

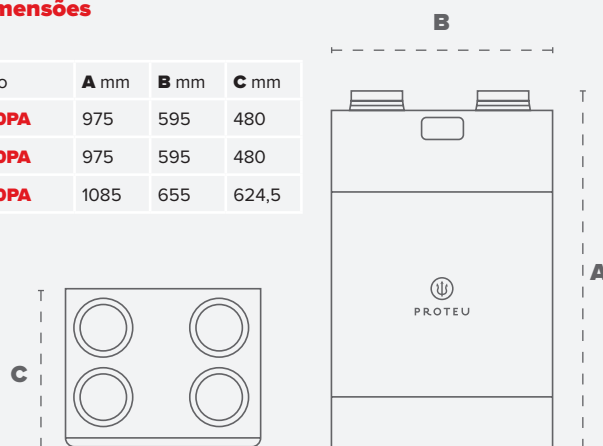

Adicione o seu equipamento à aplicação **Smart life** e obtenha em tempo real todas as informações acerca do seu funcionamento.



Alta
Eficiência



WIFI
Incluído



Produto
Certificado



Filtros
G4 e F7



Sensor
Humidade e CO²

Proteu® ~~DEHA~~ e ~~DEHA~~^{PRO} Recuperador de duplo fluxo



NOVO



210mm

Perfil
baixoFiltros removíveis
e eficientesBocas
orientáveisBocas
multientrada
e multisaídaZero
vibrações

Modelo	PVP	Caudal ar [m3/h]	Controlo	Nível ruído [dB(A)]	Class. energética	Dim. condutas [mm]	Dimensões LxAxP [mm]
DH200PA	1538 €	200	0-10V	35,1	A+	2xØ130/Ø160 + 2x6Ø75	600x970x210
DHP200PA	2096 €	200	8 velocidades	35,1	A+	2xØ130/Ø160 + 2x6Ø75	600x970x210

Proteu® NARA Extrator de simples fluxo



Modelo	PVP	Caudal ar [m3/h] (Baixo/ Médio/ Alto)			Nível ruído [dB(A)] (Baixo/ Médio/ Alto)			Controlo	Dim. condutas [mm]	Dimensões LxAxP [mm]
NR270PA	247 €	108	141	245	21,1	26,5	32,2	3 velocidades	2xØ130/Ø160 + 6x6Ø75	450x450x180



NOVO

Instalação
horizontal
ou verticalBocas
multientrada
e multisaídaZero
vibrações



www.proteu.pt
conforto à distância
de um clique



**Consulte toda
a gama
de equipamentos**



**Aceda a toda
a documentação
técnica**



Apoio técnico
assistência,
manutenção
e arranque



**Acesso à rede
de distribuidores
oficiais**



Proteu®
a pensar no
seu conforto



proteu.pt